

SALICE AIR TEMPLATE KIT

There are two separate templates available for the machining of the AIR hinge; one is used for machining both the top and bottom of the door while the other is used for machining the top and bottom cabinet panels.

The top box shown below, with the part # **TZTMPLT**CAB****, contains the template used for machining the cabinet parts (top & bottom panels). "**CAB**" refers to **CABINET**. The bottom box, with the part # **TZTMPLT**DR****, contains the template used for machining the cabinet door (top & bottom). "**DR**" refers to **DOOR**.

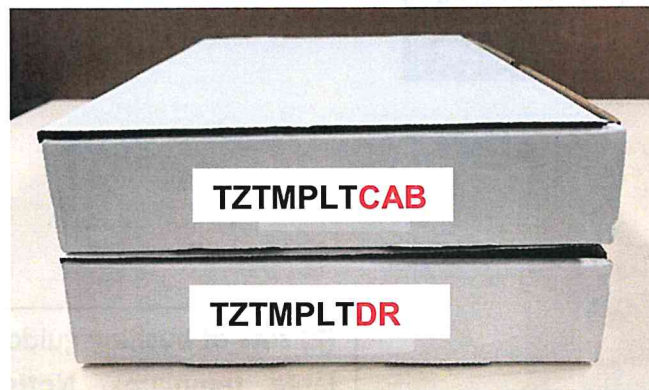

BE AWARE: All machining specifications must be pre-determined and verified prior to template setup. Be sure to calculate the cutting distances for both the doors and cabinets to be certain not to exceed the minimums and maximums for either part.

Now that you know that there are two template kits, let's take a closer look to see what is included inside the **DOOR** template box.

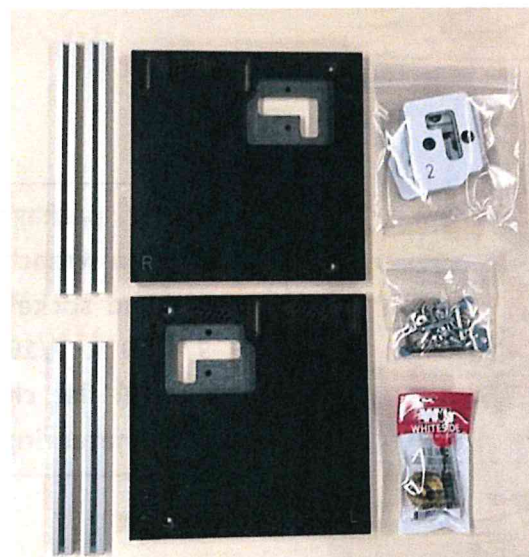

You should have:

- (4) "U" shaped aluminum channels, 2 long & 2 short.
- (2) Large black templates (1R & 1L).
- (1) Pack of bushing guide inserts
- (1) Hardware package
- (1) Whiteside Tool pack

Now, let's open the packages and examine the contents.



Whiteside, 5/16" dia., spiral up-cut router bit and 1/2" dia. brass guide bushing.

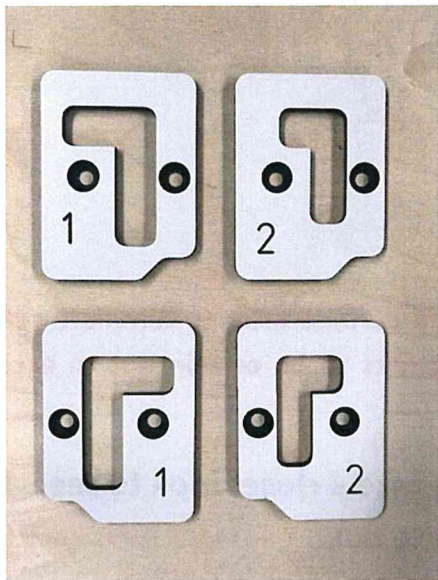

(2) sets of bushing guide inserts for the large templates. Notice the corner shapes of each set. The shape indicates which large template each particular insert set (1 & 2) matches or fits into.

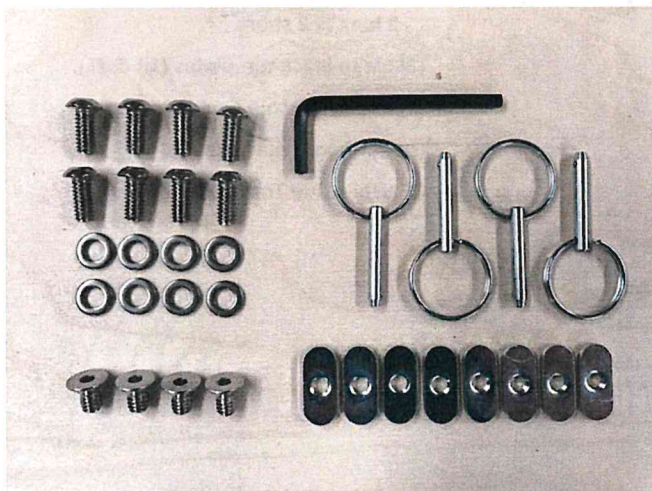

Hardware package which includes: 5/32" Allen wrench, (8) 1/4-20 x 9/16" round head socket screws & washers, (4) 1/4-20 x 7/16" flat head socket screws, (8) flat channel nuts and (4) 3/16" diameter ring pins.

Let's take a look at one of the large door templates and begin to assemble it. Shown here in Fig 1 are the round headed socket screws with washers in their proper position. The template shown here is used for machining the **RH** hinge. The templates are labeled either "L" or "R". Fig. 2 gives a bottom view showing where the alignment bars will be attached. The oblong channel nuts, when attached to the screws, should have the flat surface facing the face of the template. This will allow the channel nuts to slide into the alignment bars without possible binding. Fig. 3 shows the alignment bars attached but adjustable at this point.

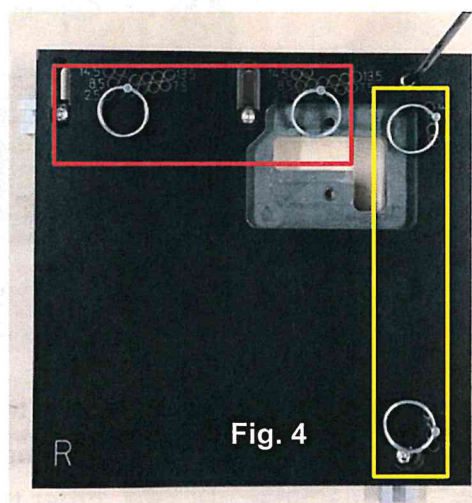
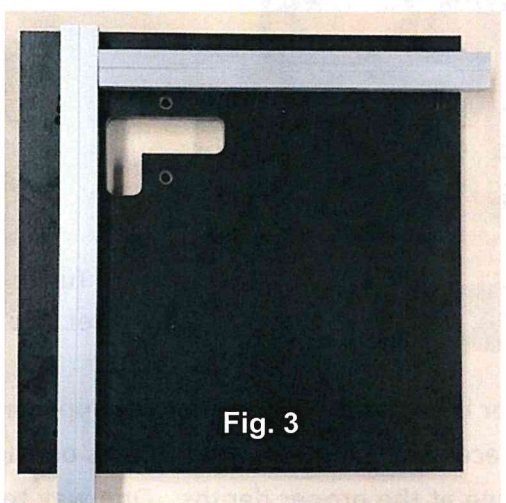
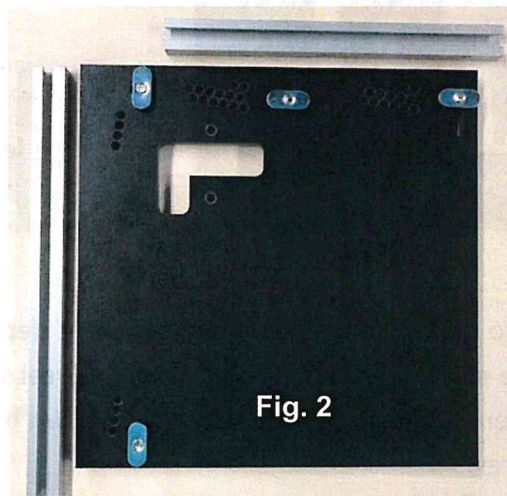
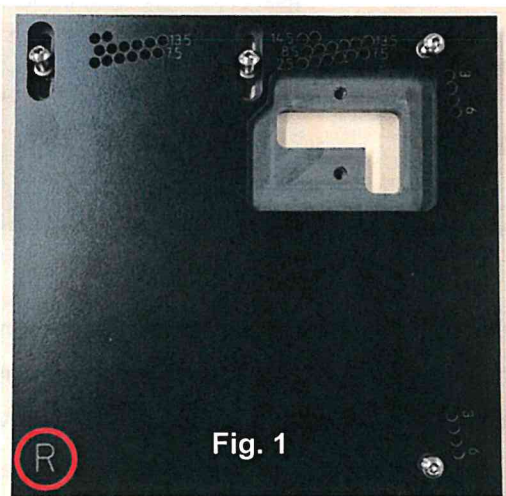

In Fig. 4 the ring pins are inserted in the desired holes to locate the aluminum guide rails underneath the template. The engraved numbers beside the holes indicate the cutting distance from the guide rails in 1 mm increments. These guide rails form a right angle in order to align the template with the corner of the door so the cut can be precisely made. The two pins for each set of holes within the **red box** establish the top or bottom overlay of the door. This is shown as the "Y" value in the catalog. When the pins are inserted into the holes for the desired overlay, the guide bars are pressed against the pins and then the screws are tightened by using the 5/32" Allen wrench to secure them in place. (**Note:** The pins have a spring loaded detent ball in the pin shaft. Before pressing the guide rails against the pins, make sure to **fully** insert the pins. By doing so, the ball will then be below the bar and will not interfere with the alignment since it may cause the bar to stand off the pin slightly possibly causing misalignment of the template with the door. Within the **yellow box** is the set of holes which establishes the "K1" drilling distance of 3-6 mm (Refer to your catalog). Once these two pins are fully inserted, these guide rails can then be secured in place. **Remove all ring pins when the setup is complete and before attempting to make any cuts.**

The router guide plate can now be set into the template. It is fixed by using two the flat head socket screws. Tighten using the 5/32" Allen wrench. Each template, L & R, comes with a L & R set of guide plates. Since the hinge pocket is a two step machining process (illustrated in Fig. 5), once the cut made using the No. 1 guide is complete it is then replaced with the No. 2 guide and that cut is made. The hinge pocket is then finished.

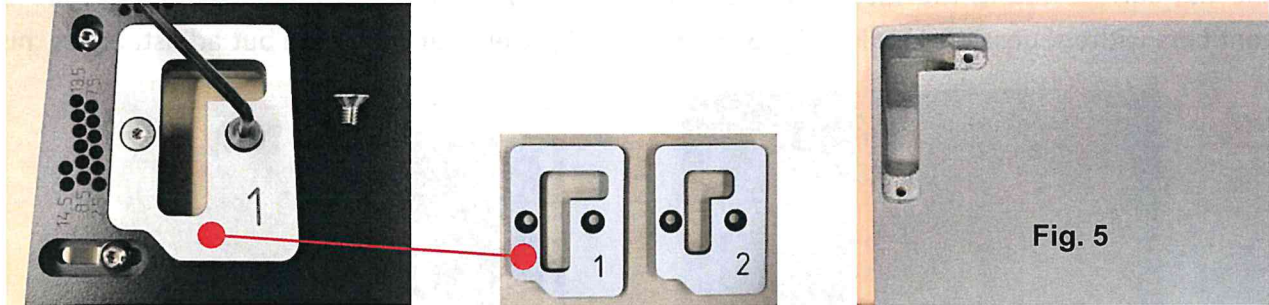

Router Prep

Since having to make two cuts, each at different depths with the same bit, it is highly recommended that you have two large plunge routers equipped with turret type stop devices. Make sure the turret stop devices will provide sufficient depth range for each cut. Shown below in Fig. 6 is an example of a turret stop with different length stop screws.

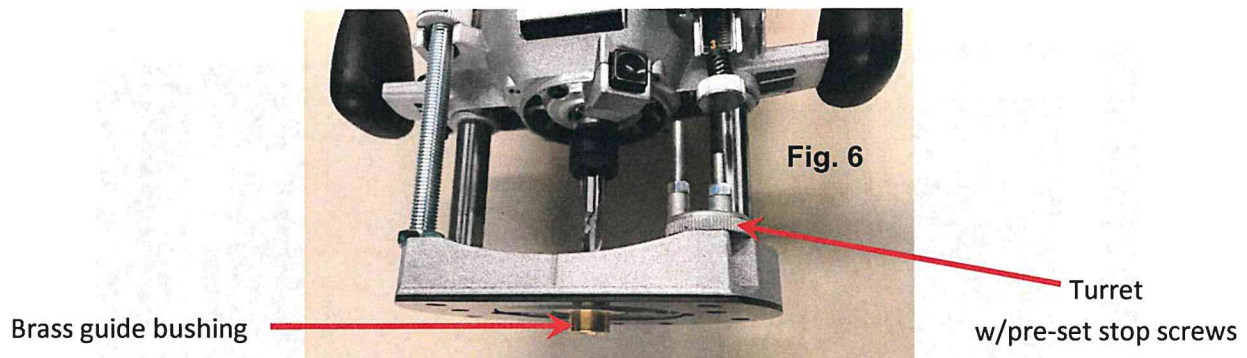

Once the router is prepped with the bit and appropriate guide bushing, it is necessary to set the stop screws on the turret in order to machine at the proper depths. One way to do this is by inverting the router and placing the template upside down onto the base of the router. By pressing downward on the template, the bit then protrudes through the template base and bushing. A measurement of the existing depth setting can then be made. By adjusting one of the stop screws you can fine tune to the proper depth when using that particular stop on the turret. Once the depth is what you want, use a wrench and lock the stop screw using the jamb nut. Repeat the process for cut number 2. Now that your turret stops are properly set, you are ready to machine the door hinge pockets as shown on the following page.

Position the template on the face/corner of the door as shown below. Securely clamp the template/door to a solid work surface such as a workbench so as not to be able to move around.

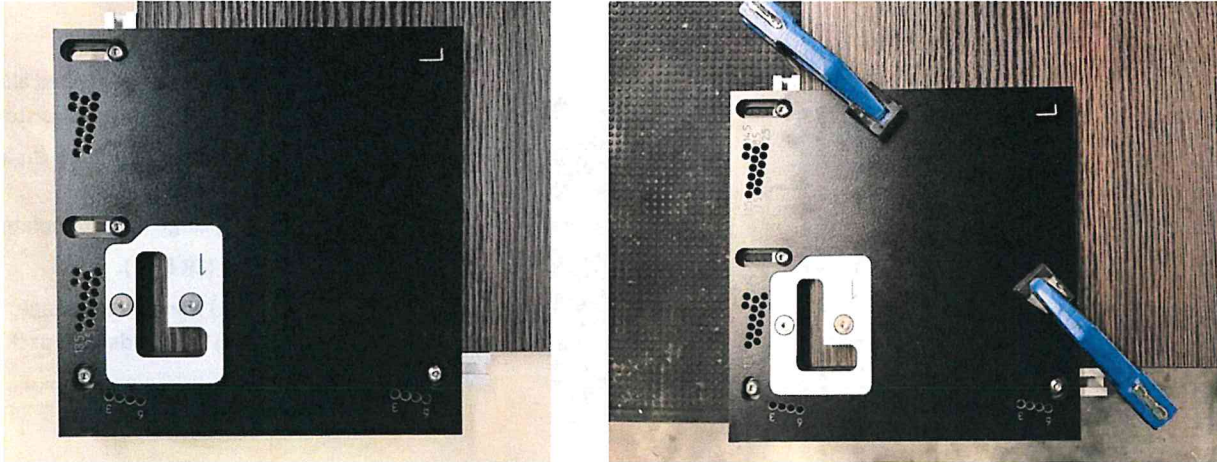

Note that the brass guide bushing must follow the inside edge of the white guide insert plate. It will be necessary to clear out the chips/dust periodically to prevent possible obstruction of the guide bushing against the guide plate. A final cleanup pass is recommended.

Rout using guide insert plate No. 1. Use the long pin stop for the 3 mm deep cut.

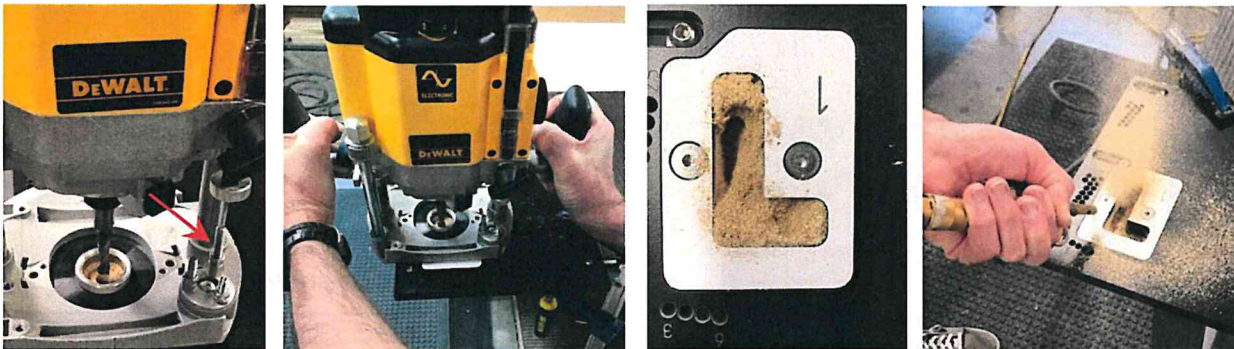

Rout using guide insert plate No. 2. Use the short pin stop for the 16.5 mm deep cut.

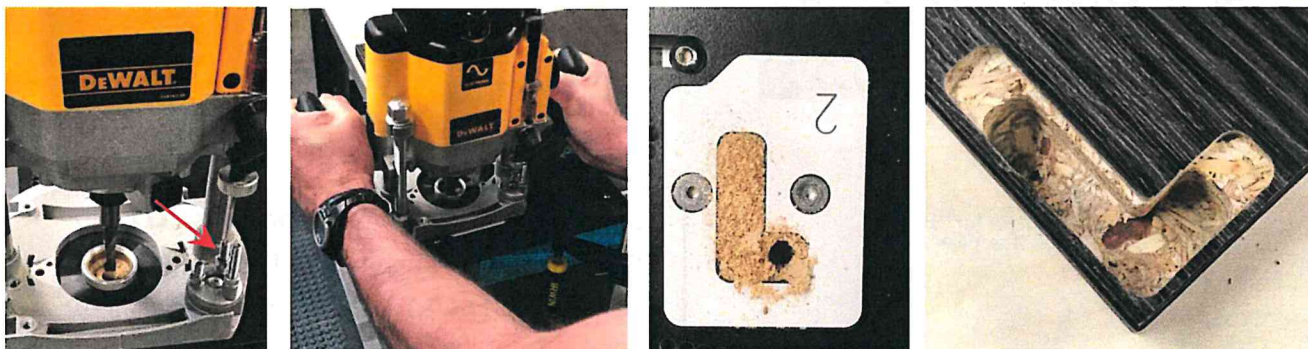

Cut numbers 1 & 2 are now complete with pocket cleaned out ready for final assembly. The hinge should be able to be inserted into the cut with little resistance. It is highly advisable to drill 5/64" dia. pilot holes for the attachment screws prior to final assembly to prevent possible splitting by the screws. **DO NOT OVER-TORQUE THE ATTACHMENT SCREWS AS THIS MAY STRIP THE HOLE OF ITS HOLDING POWER!**

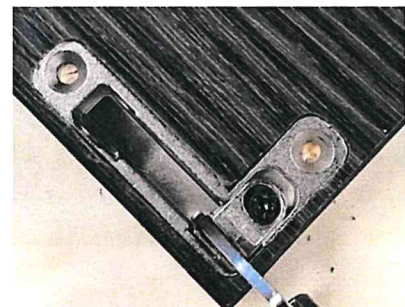

Let's take a look inside the **Cabinet** template box.

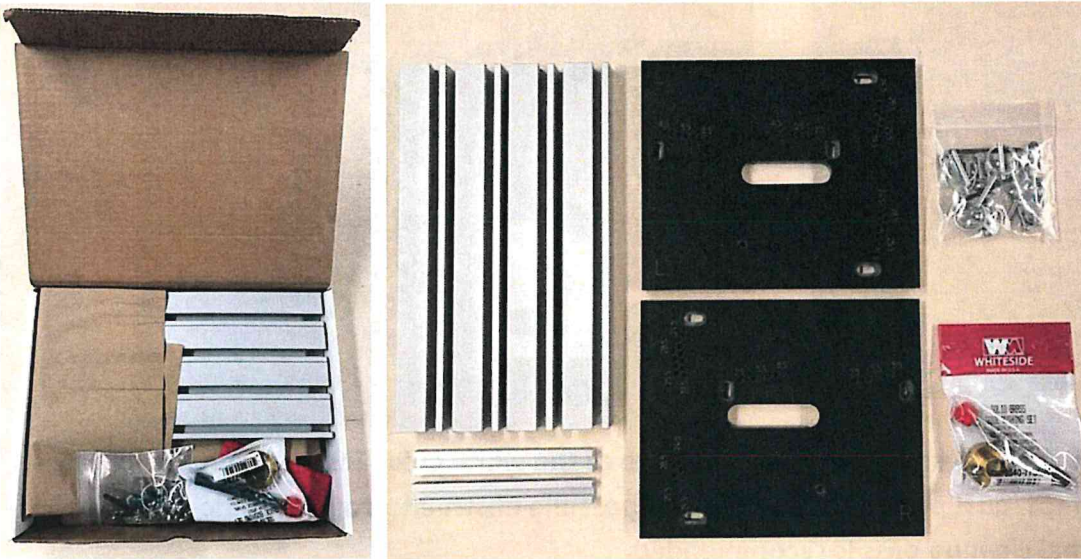

- You should have:
- (2) Short "U" shaped aluminum channels used as stop bars.
 - (4) Long aluminum channel guide rails.
 - (2) Large black templates (1R & 1L).
 - (1) Hardware package
 - (1) Whiteside Tool pack

Now, let's open the packages and examine the contents.



Whiteside 10 mm dia., spiral up-cut router bit and 3/4" dia. brass guide bushing.

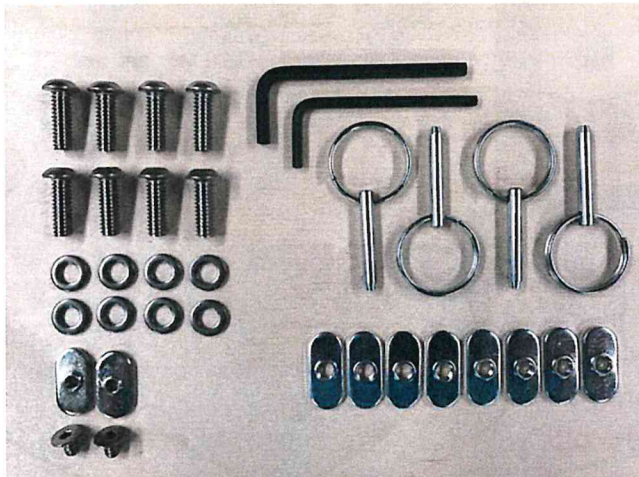

Hardware package which includes: (1) 5/32" Allen wrench, (1) 1/8" Allen wrench, (8) 1/4-20 x 3/4" round head socket screws & washers, (2) 10-24 x 5/16" flat head socket screws, (8) flat channel nuts for long guide rails, (2) flat channel nuts for small aluminum stop bars and (4) 3/16" diameter ring pins.

Now for the cabinet machining.

Let's take a look at one of the large cabinet templates and begin to assemble it. Shown here in Fig 7 are the round headed socket screws with washers in their proper position. The template shown here is used for machining the RH hinge. The templates are labeled either "L" or "R". Fig. 8 gives an underside view showing where the alignment bars will be attached. The oblong channel nuts, when attached to the screws, should have the flat surface facing the face of the template. This will allow the channel nuts to slide into the alignment bars without possible binding. Fig. 9 shows the alignment bars attached but adjustable at this point.

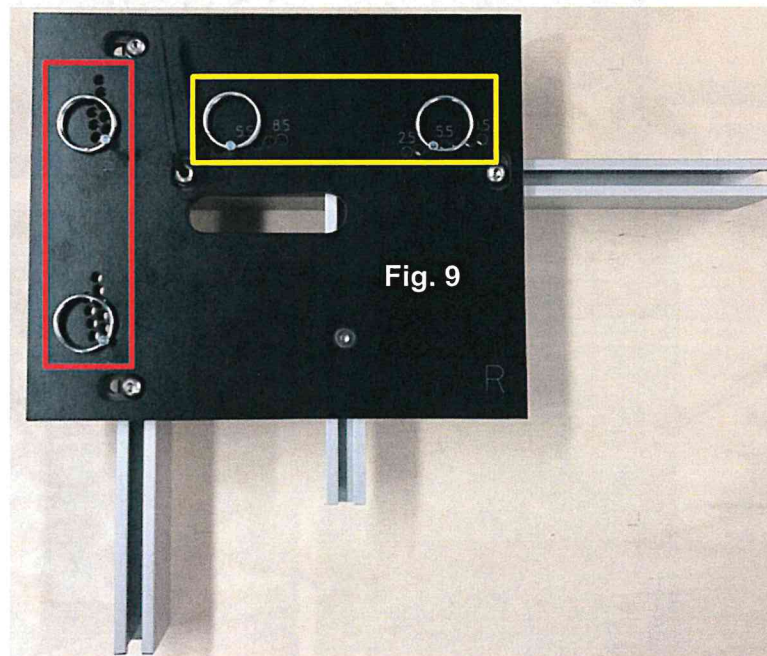

In Fig. 9 the ring pins are inserted in the desired holes to locate the (2) aluminum guide rails underneath the template. The engraved numbers beside the holes indicate the cutting distance from the guide rails in 1 mm increments. These guide rails form a right angle in order to align the template with the corner of the cabinet so the cut can be precisely made. The two pins for each set of holes within the red box establishes the "K2" value of the hinge body to the cabinet side. When the pins are inserted into the holes for the desired overlay, the guide bars are pressed against the pins and then the screws are tightened by using the 5/32" Allen wrench

to secure them in place. (**Note:** Rotate the pins so the ball in the pin does not create distance between the pin and guide rail. Within the **yellow box**, is the set of holes which establishes the "X" value of the hinge to the top or bottom of the cabinet.). Once these two pins are inserted, these guide rails can then be pressed against the pins and secured in place. **Remove all ring pins when the setup is complete and before attempting to make any cuts.**

The smaller bars are used when making the deep cut. When the flat head socket screw is loosened, the bar can be **slid into position (Fig. 10)** and secured using the 1/8" Allen wrench. The stop bar is **pulled out of the way (Fig. 11)**, then secured in order to make the shallow cut.

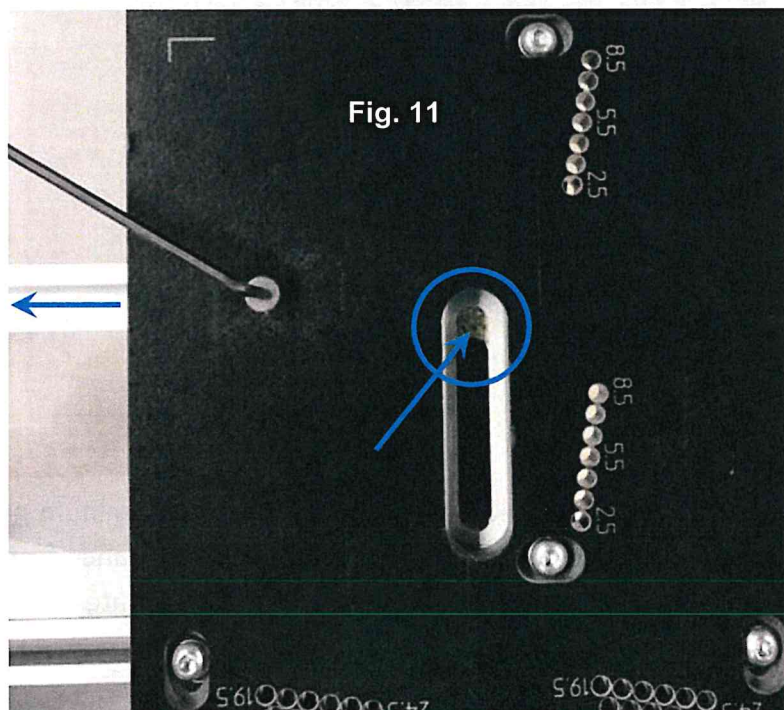
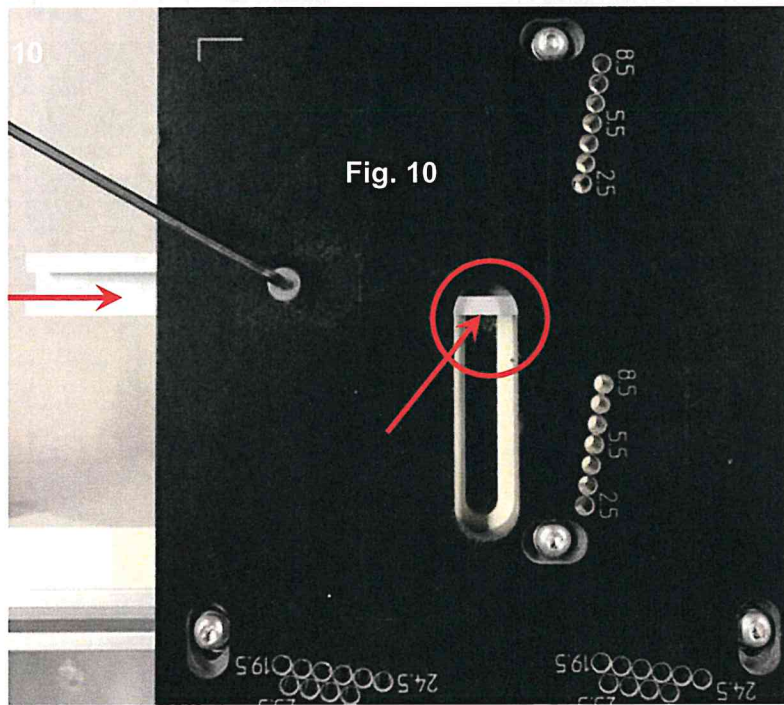

Router Prep

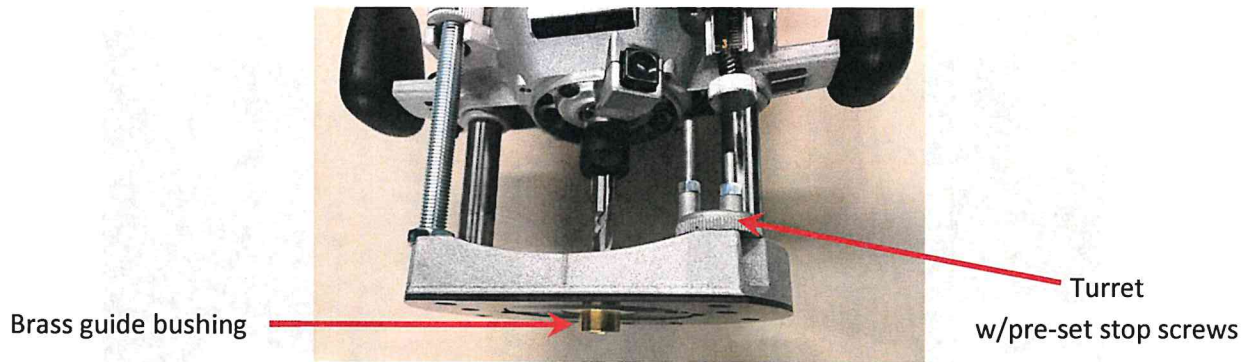

Prep the router with the appropriate bit and guide bushing, to make the 3 mm and 42 mm deep cuts. It is necessary to set the stop screws on the turret in order to machine at the proper depths. One way to do this is by inverting the router and placing the template upside down onto the base of the router. By pressing downward on the template, the bit then protrudes through the template base and bushing. A measurement of the existing depth can then be made. By adjusting one of the stop pins you can fine tune to the proper depth when using that particular stop on the turret. Once the depth is what you want, use a wrench and **lock** the stop screw using the jamb nut. Repeat the process for cut number 2. Now that your turret stops are properly set, you are ready to machine the cabinet hinge pockets as shown below.

Position the template on the face/corner of the cabinet as shown below. Securely clamp the template to the face of the cabinet side panel.

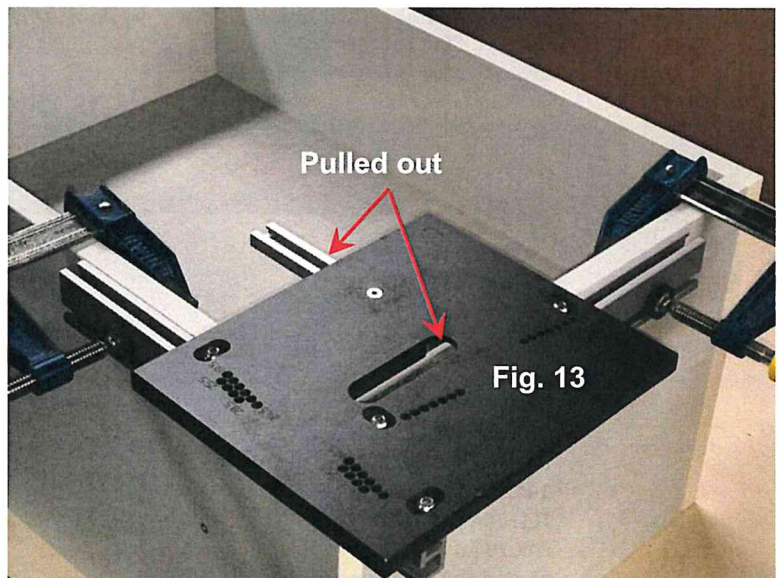
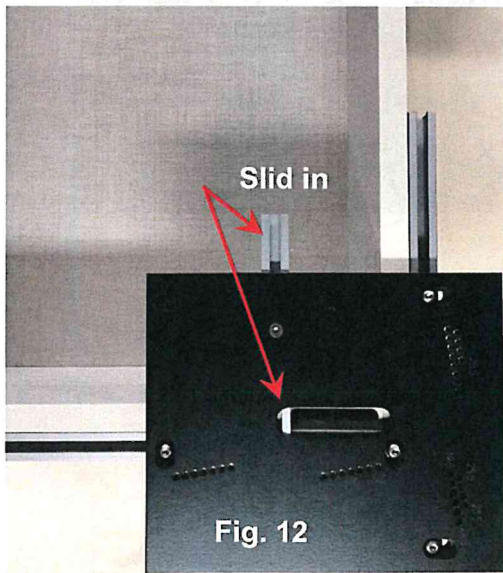

Rout using each step for each cut. The completed cut is shown at the bottom of the page.



Short stop/deepest cut (42 mm)
with stop bar pushed in as
shown in Fig. 12.



Long stop/shallow cut (3 mm)
with stop bar pulled out as
shown in Fig. 13.

The picture on the left below shows the completed pocket cut. The photo on the right shows the hinge after being fully inserted into the pocket. It is highly advisable to drill a 5/64" pilot hole for the attachment screw prior to final assembly to prevent possible splitting by the screw. **DO NOT OVER TORQUE THE ATTACHMENT SCREW AS THIS MAY STRIP THE HOLE OF ITS HOLDING POWER!**

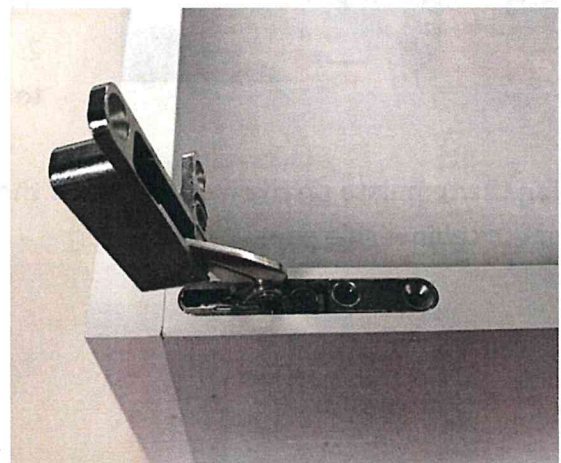

SALICE AMERICA INC.
2123 CROWN CENTRE DRIVE
CHARLOTTE, NC 28227
1-800-222-9652
TEL. 704 841 7810
FAX 704 841 7808
info.salice@saliceamerica.com
www.saliceamerica.com

SALICE CANADA INC.
4025 SLADEVIEW CRESCENT UNIT # 7-9
MISSISSAUGA, ONTARIO L5L 5Y1
TEL. 905 820 8787
FAX 905 820 7226
info.salice@salicecanada.com
www.salicecanada.com